



Installation Support • Soporte de instalación • Support d'installation

Personal Assistance, Product Specs, & "How-to" Questions:

Asistencia personal, especificaciones del producto y preguntas sobre "cómo hacerlo":
Aide personnelle, spécifications du produit et questions « pratique-pratiques » :

1-800-PFAUCET (732-8238)
pfisterfaucets.com/support

Installation Videos Available
Videos de instalación a disposición
Vidéos d'installation disponibles



pfisterfaucets.com/videos



WARNING / ADVERTENCIA / AVERTISSEMENT

To reduce the risk of injury or property damage, read all instructions before installing product. Wear safety goggles. Product must be installed in accordance with all state & local plumbing & building codes. Call a professional if you are uncertain about installing this product.

Para disminuir el riesgo de lesiones o daños a la propiedad, lea todas las instrucciones antes de instalar el producto. Utilice gafas de seguridad. El producto deberá instalarse de acuerdo con la normativa de plomería y construcción estatal y local. Llame a un profesional si no está seguro sobre cómo instalar este producto.

Pour réduire le risque de blessures ou de dommages, lire toutes les instructions avant d'installer le produit. Porter des lunettes de sécurité. Le produit doit être installé en conformité avec tous les codes de construction et de plomberie locaux et de l'état. Appelez un professionnel si vous n'êtes pas certain de la façon d'installer ce produit.

Required Tools
Herramientas necesarias
Outils nécessaires

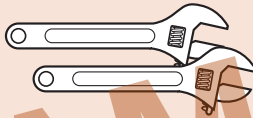

Adjustable Wrenches
Llaves ajustables
Clés à mollette



Safety Goggles
Anteojos de seguridad
Lunettes de sûreté

Additional Helpful Tools
Otras herramientas útiles
Outils supplémentaires utiles

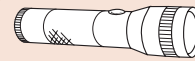

Flashlight
Linterna
Lampe De Poche



Cloth
Paño de limpieza
Chiffon

Parts in the Box
Piezas en la caja
Pièces dans la boîte

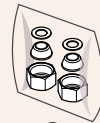
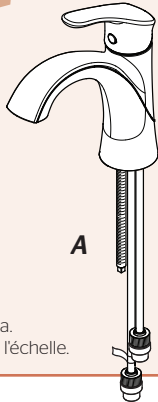

Aerator Tool
Herramienta aireador
Outil d'aérateur

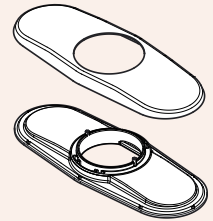

Optional Deck Plate (not included) see page 3.
Placa de cubierta opcional (no incluido), véase la página 3.
Plaque de pont en option (non inclus), voir page 3.

1 Turn Off Water Supply • Cierre el suministro de agua • Couper l'alimentation en eau



Locate water supply inlets and shut off the water supply valves. These are usually found under the sink or near the water meter. If you are replacing an existing faucet, remove the old faucet from the sink and clean the sink surface thoroughly.

Ubique las entradas del suministro de agua y cierre las válvulas de suministro de agua. Generalmente se encuentran debajo del fregadero o cerca del medidor de agua. Si se trata de un reemplazo de grifo, quite el grifo viejo y limpie completamente la superficie del fregadero.

Recherchez les entrées d'approvisionnement et fermer leurs robinets. Ces robinets se trouvent généralement sous l'évier ou près du compteur d'eau. Si vous remplacez un robinet existant, retirez, le vieux robinet de l'évier et nettoyer soigneusement la surface de ce dernier.

Hot
Caliente
Chaud

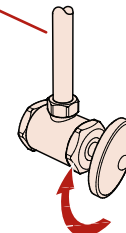

Cold
Fría
Froid

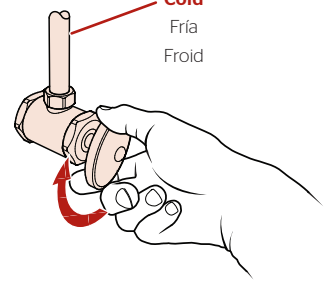

2

Install Faucet **without Deckplate**

Instale el grifo sin la placa de cubierta

Installer le robinet sans le plate-forme

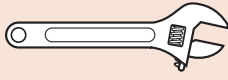

Adjustable Wrench
Llave ajustable
Clé réglable

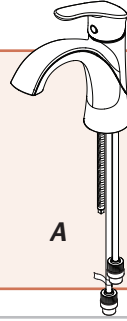

A

B

C

D

2A

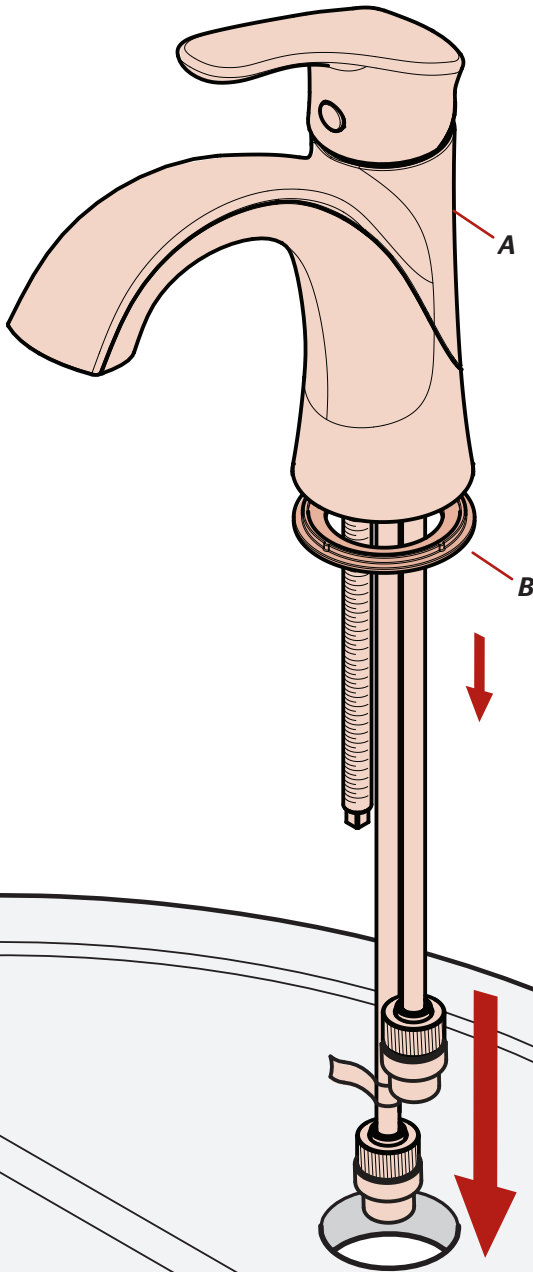

2B



**Be sure the spout body (A) is centered & facing forward.
IMPORTANT: DO NOT OVERTIGHTEN.**

Cerciórese que la estructura del surtidor (A) esté centrada y orientada hacia adelante.
IMPORTANTE: NO APRIETE EXCESIVAMENTE.

Assurez-vous que le corps du bec (A) est centré et tourné vers l'avant.
IMPORTANT: NE PAS TROP SERRER.



Bumps face up.
Topa cara arriba.
Cogne récepteur.

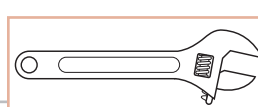
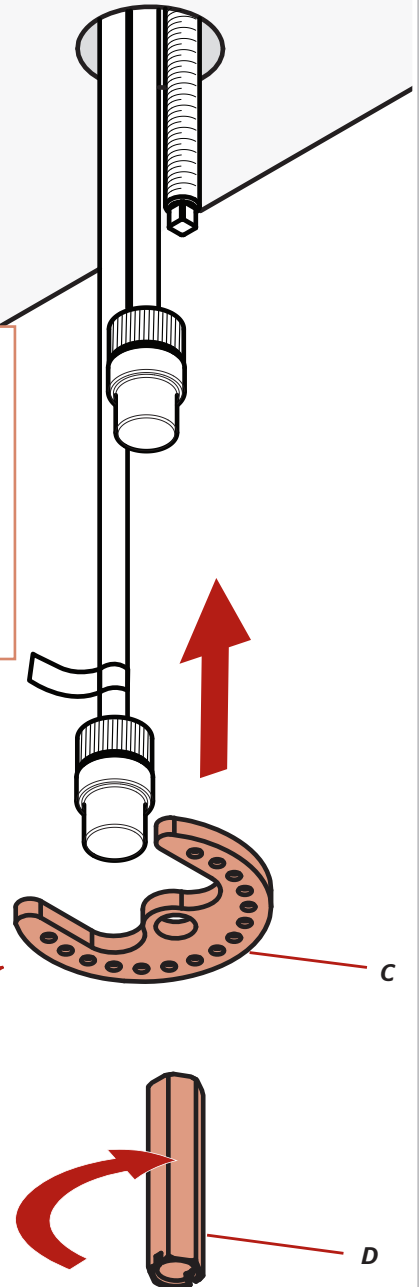

2

OPTION: Install Faucet **with Deckplate**

OPCIÓN: Instale el grifo con la placa de cubierta

OPTION: Installer le robinet avec le plate-forme

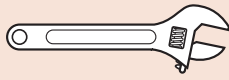

Adjustable Wrench
Llave ajustable
Clé réglable

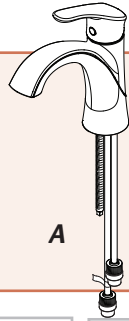

A



B



C



D



Optional Deck Plate
Placa de cubierta opcional
Plaque de pont en option

2A

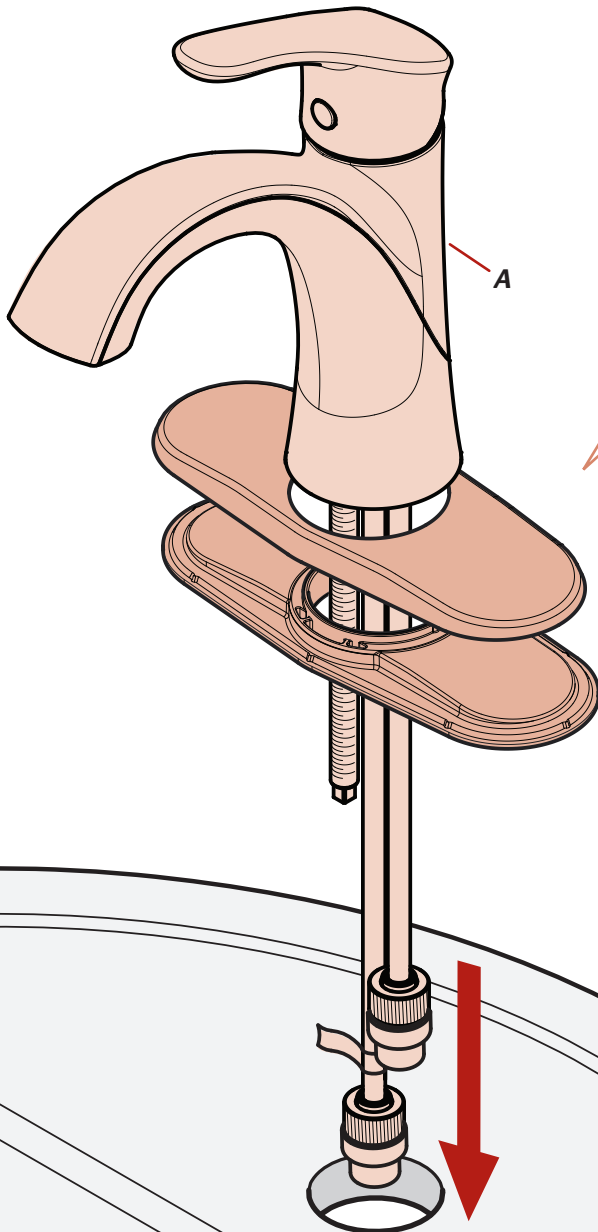

2B

Optional Deck Plate, see Maintenance & Care Guide, page 2, Call 1-800-732-8238 to order.

Placa de cubierta opcional, consulte la Guía de Mantenimiento y Cuidado de la página 2, llame al 1-800-732-8238 para ordenar.

Plaque de pont en option, consultez le Guide de maintenance et d'entretien, page 2, Appelez 1-800-732-8238 à l'ordre.



Be sure the spout body (A) is centered & facing forward.

IMPORTANT: DO NOT OVERTIGHTEN.

Cerciórese que la estructura del surtidor (A) esté centrada y orientada hacia adelante. **IMPORTANTE: NO APRIETE EXCESIVAMENTE.**

Assurez-vous que le corps du bec (A) est centré et tourné vers l'avant. **IMPORTANT: NE PAS TROP SERRER.**

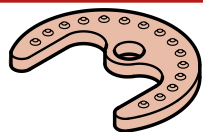

Bumps face up.

Topa cara arriba.
Cogne récepteur.

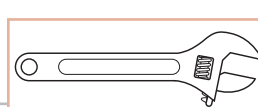
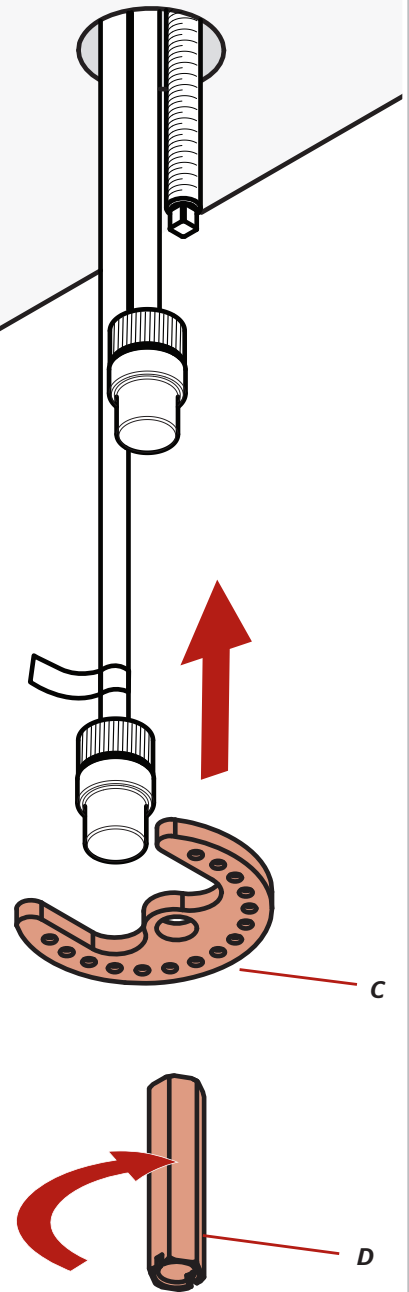

3 Connect Water Supply Lines Conecte las tuberías de suministro de agua Raccorder les conduites d'alimentation en eau

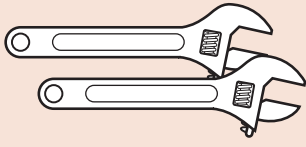

Adjustable Wrenches
 Llaves ajustables
 Clés à mollette



E (x2)

Water Supply Lines not included. Please consult manufacturer and/or its instructions for the correct method of installation of supply lines & fittings.

IMPORTANT: Incorrect application of supply lines and fittings may result in the failure or leak of the supply lines and fitting.

Las tuberías de suministro de agua no están incluidas. Consulte por favor el fabricante y/o sus instrucciones para el método correcto de instalación de líneas de suministro y de guarniciones.

IMPORTANT: El uso incorrecto de líneas de suministro y de guarniciones puede dar lugar a la falta o al escape de las líneas de suministro y de la guarnición.

Les tuyaux d'arrivée d'eau ne sont pas fournis. Veuillez consulter le fabricant et/ou ses instructions pour la méthode correcte d'installation des conduites d'alimentation en eau et des accessoires.

IMPORTANT: Mauvaise application des lignes d'alimentation et accessoires peut entraîner la défaillance ou la fuite.

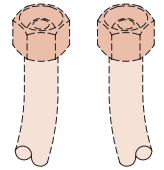

HOT
CALIENTE
CHAUD

COLD
FRÍA
FROID

3A **x2**
Hot & Cold
 Caliente y fría
 Chaud et froid

x2
Hot & Cold
 Caliente y fría
 Chaud et froid

3B **x2**
Hot & Cold
 Caliente y fría
 Chaud et froid

Package Only
 Empaquetado solamente
 Empaquetage seulement

Firmly hand tighten
 Firmemente apriete a mano
 Main serrez **x2**

3C

Separate tubes gently and slightly for clearance.
 Tubos separados y ligeramente suavemente para su despacho.
 Tubes séparés doucement et légèrement pour le dédouanement.

COLD
FRÍA
FROID

Water supply line
 Línea de suministro del agua
 Ligne d'approvisionnement en eau

HOT
CALIENTE
CHAUD

x2
Hot & Cold
 Caliente y fría
 Chaud et froid

4 Prepare & Install Push & Seal™ Drain

Prepare y instale cuerpo de drenaje Push & Seal™

Préparez & installez le corps de drainage Push & Seal™

No Tools Required for This Step
 No se necesitan herramientas para este paso
 Pas d'outil nécessaire pour cette étape

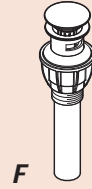

4A Disassemble Pop-Up

Desensamble el cuerpo de drenaje

Démontez le corps de drainage

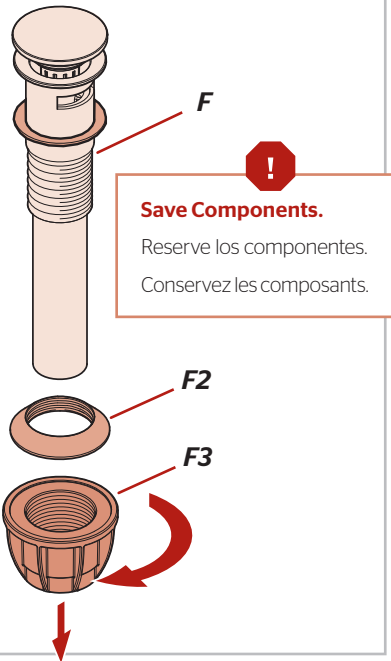

4B

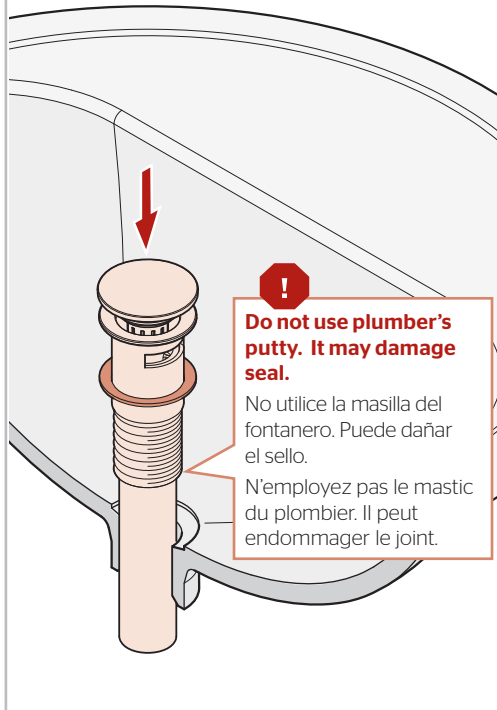

4C

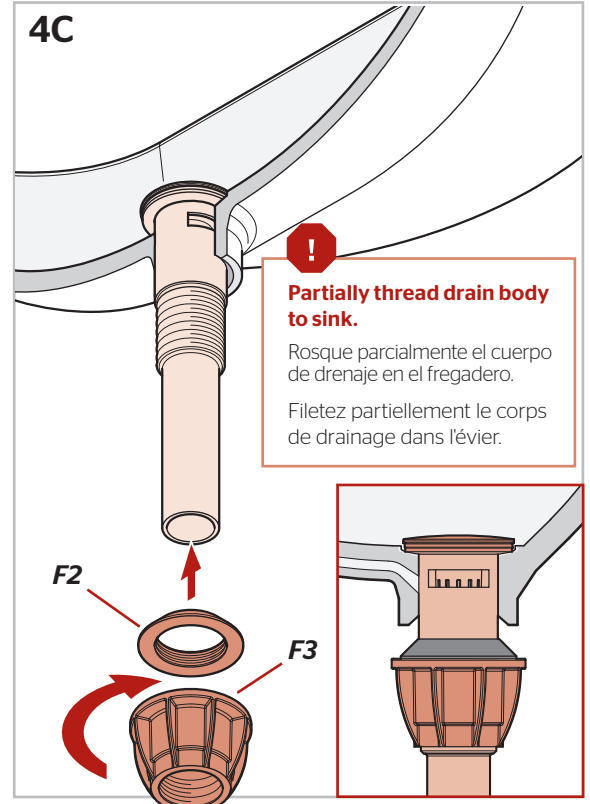

4E

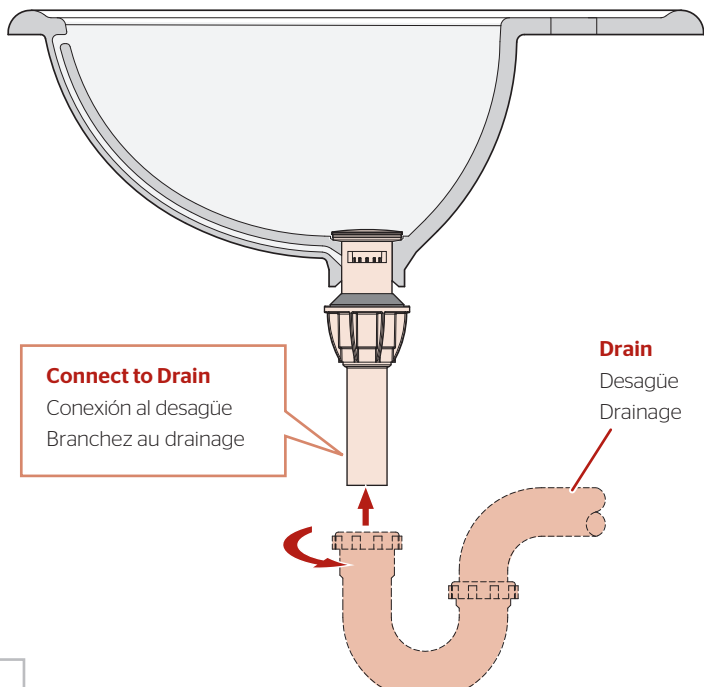

4E

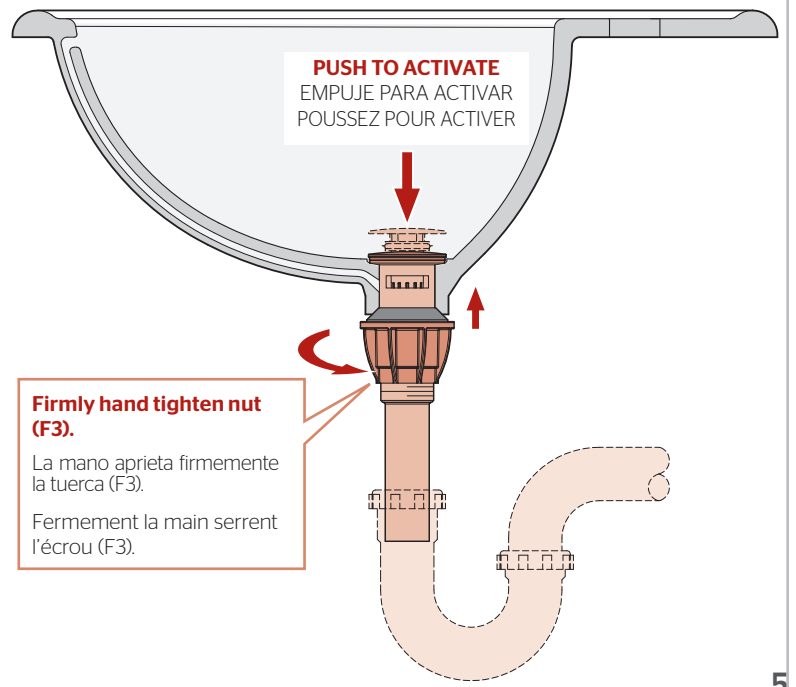

5 Remove and Set Limit Stop

Retire y Ajuste del Tope del Límite

Retirer et mettre de Stop Limit

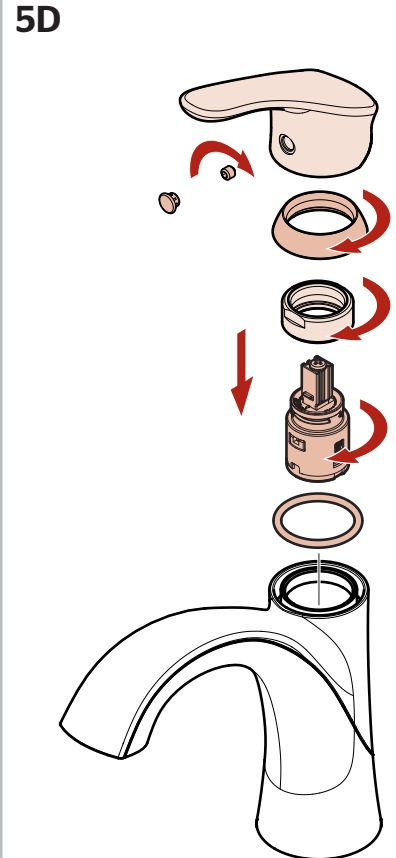
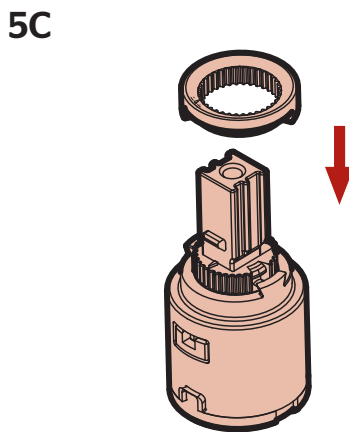
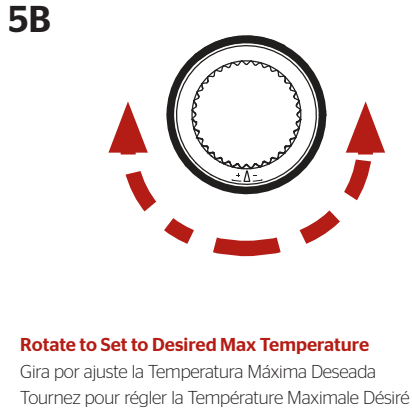
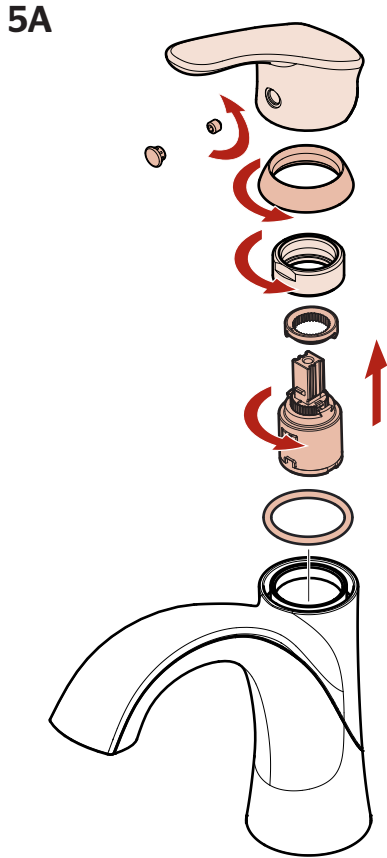

6 Turn On Water & Confirm Proper Installation

Active el suministro de agua y confirme que la instalación está adecuadamente efectuada

Ouvrez l'eau et confirmez que l'installation est correcte

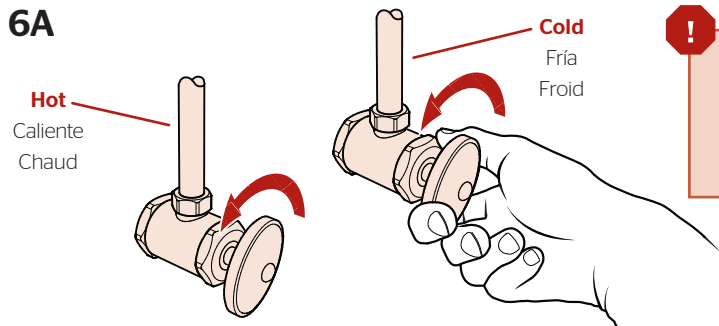

! **Check for leaks above and below the sink.**

Revise si hay fugas encima y debajo del fregadero

Assurez-vous qu'il n'y a pas de fuite au dessus ou au dessous du lavabo.

7

Faucet Function

Funciones del grifo

Fonctionnement du robinet

7A

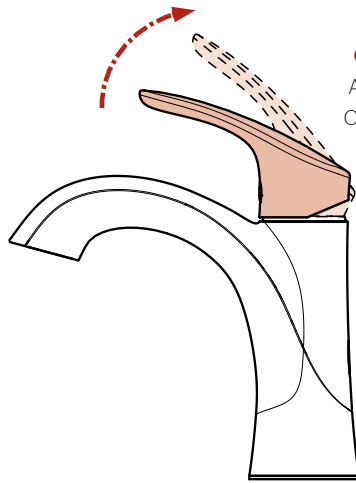

Open
Abierta
Ouvverte

Hot
Caliente
Chaud

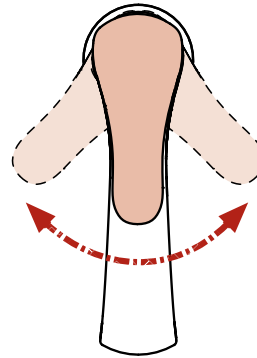

Cold
Fría
Froid

Faucet Function
Funciones del grifo
Fonctionnement du robinet

8

Flush the Faucet

Enjuague el grifo

Vidanger l'robinet

8A

Remove Aerator

Retire el aereador
Retirez l'aérateur



8B

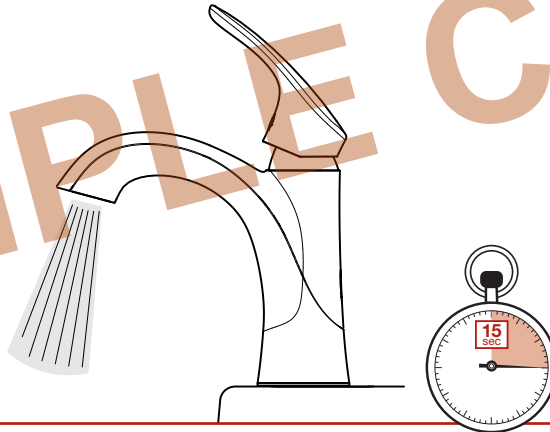

Allow full hot & full cold water to run for at least 15 seconds each.

Deje correr el agua caliente y fría durante al menos 15 segundos cada una.

Permettez à l'eau chaude et l'eau froide de couler au moins 15 secondes chacun.

8C

Reinstall Aerator

Reinstale el aereador
Réinstallez l'aérateur

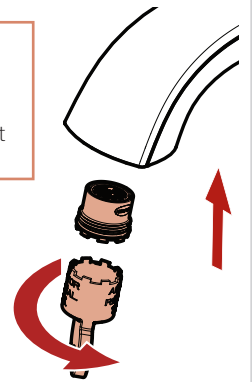

Hand Tighten

Apriete con la mano
Serrez manuellement

For Additional Installation Help:
Para la instalación adicionales de ayuda:
Pour les aides supplémentaires à l'installation:

Pfister®

1-800-PFAUCET (732-8238)
pfisterfaucets.com