

X-Stone Countertop 24"

Specification & Installation Guide

FEATURES

- Design: Countertop for above-counter basin.
- Material: X-Stone Solid Surface
- Dimension: 23-7/8" (606mm)L x 22-1/4" (564mm)W x 3/4" (20mm)H
- XTA2208-24-000-XX with no pre-cut hole. Requires cutout by on-site installer.
- XTA2208-24-100-XX with pre-cut hole for ceramic basin CB-7120-110-WH or CB-6120-110-WH
- No Backsplash
- Packaging Dimensions: 28" (711mm) x 27" (686mm) x 3" (76mm)
- Gross Weight: 27 lbs (12 kg)

FINISHES

- Glossy White (GW)
- Matte White (MW)

XTA2208-24-100-XX

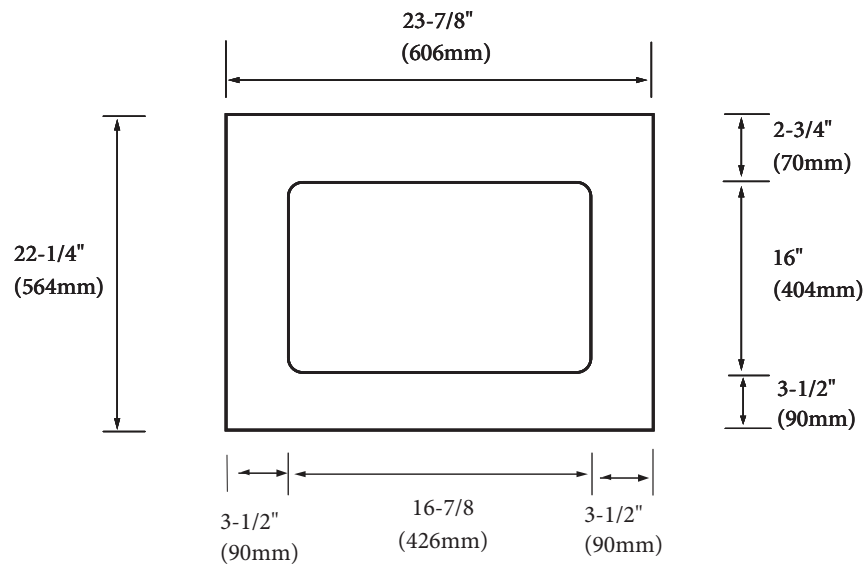

XTA2208-24-100-XX

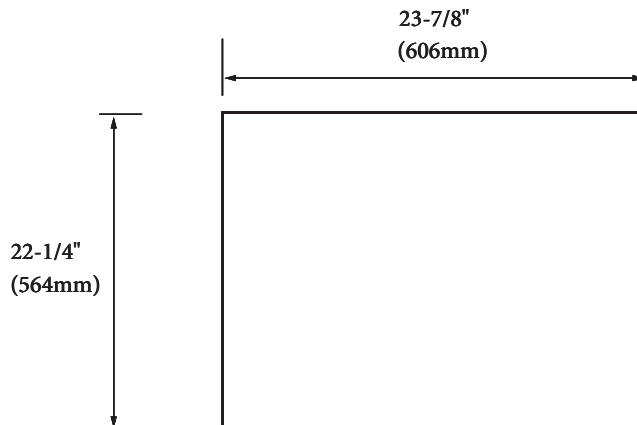

For clarification, please contact Madeli Customer Care at (800)-819-6988 or (305)-718-8817 Ext. 1

All dimensions are approximate and subject to standard tolerance. Specifications subject to change without prior notice.