



Malin™ by Studio McGee

72" bathroom vanity cabinet with sinks and quartz top
K-35023

Features

- Designed in collaboration with Studio McGee
- Set includes cabinet, precut quartz vanity top, backsplash, sinks, cabinet hardware
- Full-extension 17" (432 mm) drawers with soft-close undermount slides
- Removable dividers in top drawers to personalize drawer organization
- Three-way adjustable slow-close door hinges for easy cabinet access
- 20-7/16" (519 mm) cabinet interior provides ample storage space
- Finish-matched cabinet interior offers generous clearance for plumbing
- Two internal electrical outlets and two USB ports for powering small devices
- Two stainless steel storage holders for hairdryers, curling irons, or accessories
- Vanity top has 8" (203 mm) widespread faucet holes; requires deck-mount faucets (sold separately)
- Vibrant® Brushed Brass hardware included on White Oak vanities and Vibrant Polished Nickel hardware on White vanities. Additional hardware finishes available (sold separately)
- Coordinating side splashes available (sold separately)

Material

- Quartz vanity top adds beauty and long-lasting durability
- Vitreous china sinks
- Solid and composite wood

Installation

- Easy installation – no special tools required
- Sinks preinstalled on vanity top to simplify installation



Codes/Standards

ASME A112.19.2/CSA B45.1

KOHLER® One-Year Limited Warranty

See website for detailed warranty information.

Available Colors/Finishes

Color tiles intended for reference only.

Color	Code	Description
-------	------	-------------

	0	White
	SWK	

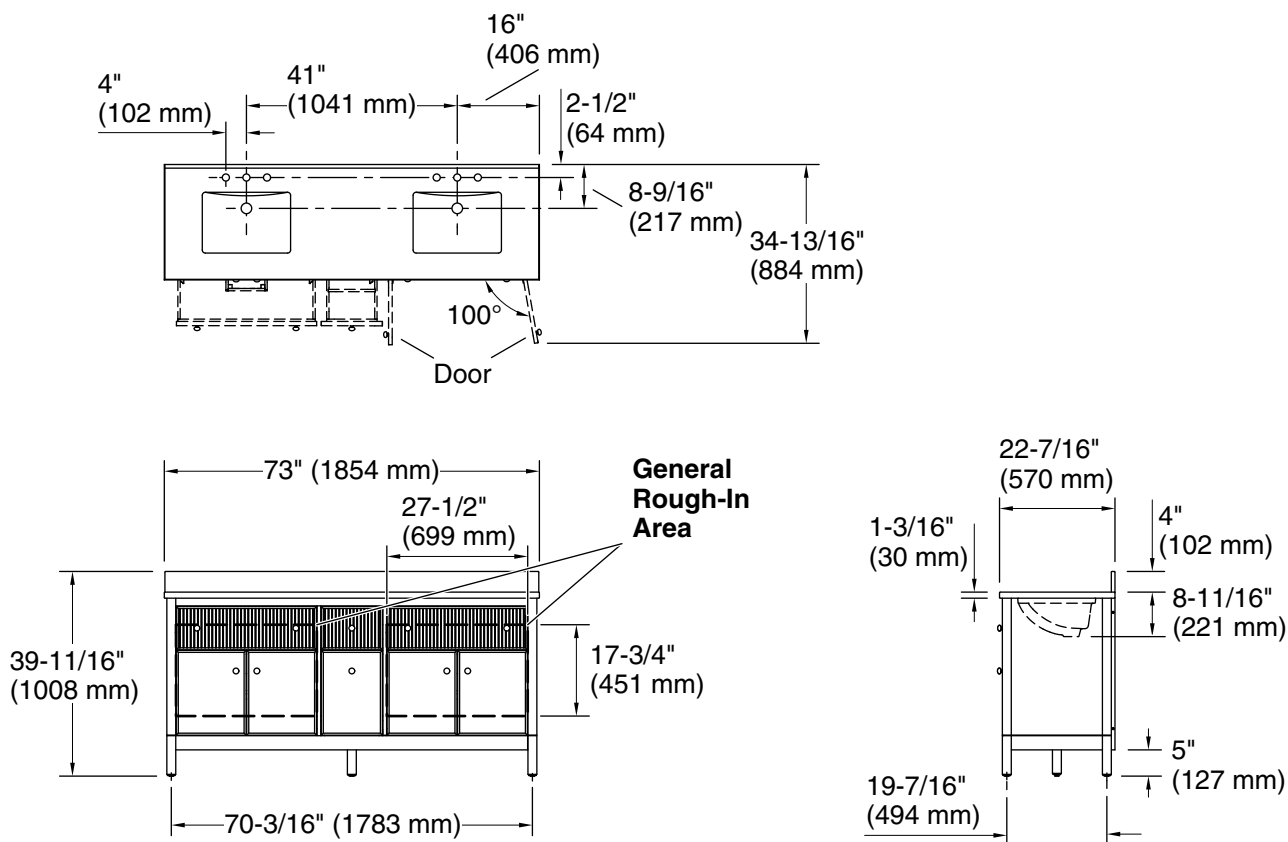

Required Electrical Service

One circuit required.

Outlet: 120 V, 12 A, 60 Hz

Technical Information

All product dimensions are nominal.

Charge voltage: USB 5 V

Electrical component rating: Outlet: 120 V, 12 A, 60 Hz

Notes

Install this product according to the installation instructions.

Select the type of fastener based upon the wall material. Two 250 lb (113.4 kg) minimum load bearing fasteners are recommended with a lag bolt of length to clear obstacles in the wall and 5/16" washers. Calculate the proper lag bolt length by adding the 1-1/2" (38 mm) backing material, plus the wallboard thickness, plus the back rail thickness.