

### Features

- Low-threshold design for easy entry and exit.
- Single threshold for three-wall installation.
- Durable acrylic construction.
- Right drain.
- Integral 18-inch undercut seat at left.
- Coordinates with other products in the Tresham collection.

### Recommended Products/Accessories

K-1733 9 kW Steam Generator  
K-702206-G54 Frameless Sliding Shower Door  
K-702206-G73 Frameless Sliding Shower Door  
K-702206-L Frameless Sliding Shower Door  
K-702207-L Frameless Sliding Shower Door  
K-702217-L Frameless Sliding Shower Door  
K-705705-L Frameless Pivot Shower Door  
K-705711-L Frameless Pivot Shower Door  
K-705717-L Frameless Pivot Shower Door  
K-705723-L Frameless Pivot Shower Door  
K-705729-L Frameless Pivot Shower Door  
K-705741-L Frameless Pivot Shower Door  
K-705810-L Semi-Frameless Pivot Shower Door  
K-705811-L Semi-Frameless Pivot Shower Door  
K-705824-L Semi-Frameless Pivot Shower Door  
K-705825-L Semi-Frameless Pivot Shower Door  
K-706009-D3 Frameless Sliding Shower Door  
K-706009-L Frameless Sliding Shower Door  
K-706012-L Frameless Sliding Shower Door  
K-706013-L Frameless Sliding Shower Door  
K-706015-D3 Frameless Sliding Shower Door  
K-706015-L Frameless Sliding Shower Door  
K-706019-L Frameless Sliding Shower Door  
K-9132 Shower Drain

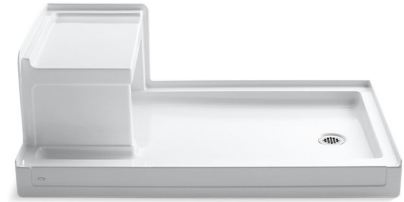

### Codes/Standards







CSA B45.5/IAPMO Z124  
ASTM E162  
ASTM E662

### KOHLER® Plastic Baths and Receptors Lifetime Limited Warranty

See website for detailed warranty information.

### Available Colors/Finishes

*Color tiles intended for reference only.*

Color	Code	Description
	0	White
	96	Biscuit
	47	Almond
	NY	Dune
	95	Ice™ Grey
	G9	Sandbar

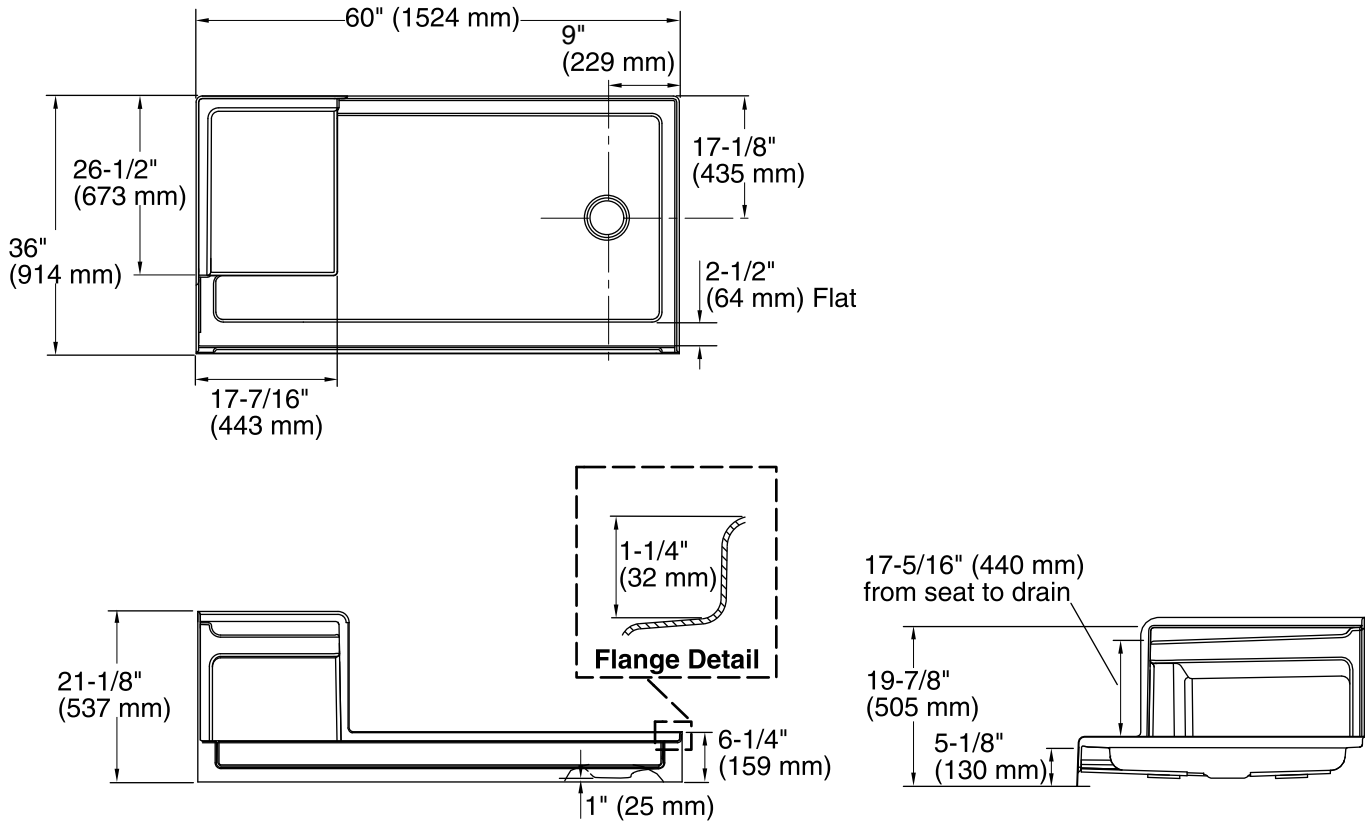

## Technical Information

All product dimensions are nominal.

Installation:	Three-wall alcove
Drain location:	Right
Weight:	79.5 lbs (36.1 kg)
Minimum floor load:	20 lbs/ft <sup>2</sup> (97.6 kg/m <sup>2</sup> )

## Notes

Measure your actual product for rough-in details. Install this product according to the installation instructions.

Shimming may be required between the stud frame and the fixture.

Stud opening tolerance is +1/4" (6 mm), -0" (0 mm).

KOHLER steam generator/control kit are designed for use with this product. Kohler Co. shall not be responsible for problems encountered due to the installation and use of other manufacturer's steam generators.