

Features

- 72"L x 36"W x 20"H
- Six adjustable ProFlex® whirlpool jets for maximum bather comfort
- Drop-in or three-wall alcove installation
- Innovative technology enables this pump to provide a strong, steady level of hydro-massage
- Constructed of acrylic
- Textured bottom surface

Hydrotherapy

- Whirlpool

Additional Hydrotherapy Options

- Soaking Bath - 1259-0
- Soaking Bath + Bask heated surface - 1259-W1
- BubbleMassage air bath - 1257-G
- BubbleMassage air bath + Bask heated surface - 1257-GW
- VibrAcoustic - 1257-VB
- VibrAcoustic + Bask heated surface - 1257-VBW
- Whirlpool - 1257-0
- Whirlpool + heater - 1257-H
- Whirlpool + Bask heated surface - 1257-W1

Recommended Products/Accessories

K-1283 Removable Apron
K-1491 Bath/Whirlpool Pillow
K-7166-AF Bath Drain
K-24916 Wireless Music Kit
K-1601 Bath/Whirlpool Footstop
K-7213 27" Cable Bath Drain
K-7214 27" Cable Bath Drain
K-7259 Clearflo Bath Drain



Codes/Standards

ASME A112.19.7/CSA B45.10
CSA B45.5/IAPMO Z124
ASTM E162
ASTM E662
UL 1795





**KOHLER® Plastic Baths and Receptors
Lifetime Limited Warranty
KOHLER® Hydrotherapy Components
Five-Year Limited Warranty**

See website for detailed warranty information.

Available Colors/Finishes

Color tiles intended for reference only.

Color	Code	Description
-------	------	-------------

	0	White
	96	Biscuit
	47	Almond
	NY	Dune
	G9	Sandbar

Pump/Control Access (If Apron Is Not Used):
20" (508 mm) W x 15" (381 mm) H

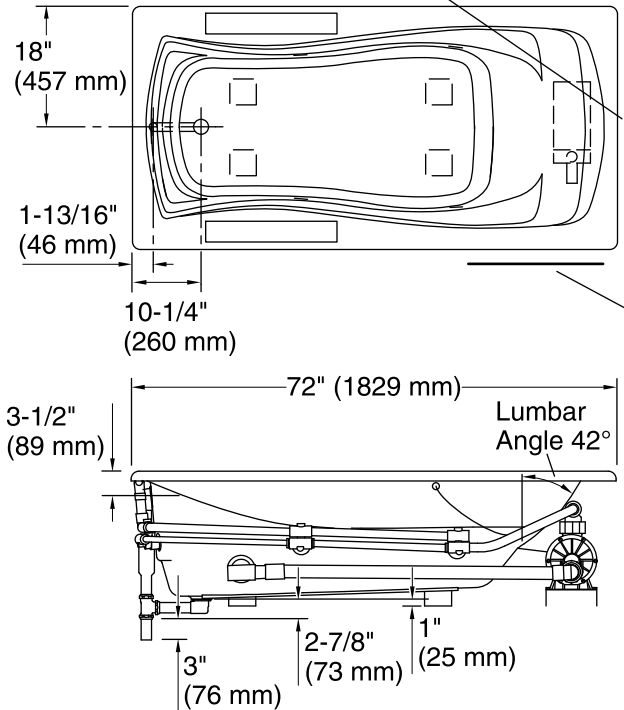

No change in measurements if connected with drain illustrated. (K-11677)

□ Recommended Faucet Location

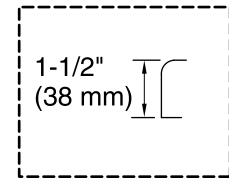

Drop-In Rim Detail

Pump/Control Access
(If Apron Is Not Used):
20" (508 mm) W x
15" (381 mm) H

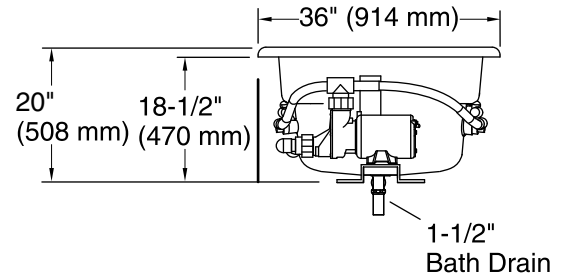

Required Electrical Service

One dedicated circuit required, protected with Class A Ground-Fault Circuit-Interrupter (GFCI). Outside North America, this device may be known as a Residual Current Device (RCD).

Pump: 120 V, 15 A, 60 Hz

Technical Information

All product dimensions are nominal.

Installation:	Drop-in
Drain location:	End
Basin area, bottom:	50" x 24" (1270 mm x 610 mm)
Basin area, top:	65" x 27" (1651 mm x 686 mm)
Weight:	110 lbs (49.9 kg)
Minimum floor load:	41 lbs/ft ² (200.2 kg/m ²)
Water depth:	14" (356 mm)
Water capacity:	72 gal (272.5 L)
Cutout:	Drop-in, 70" x 34" (1778 mm x 864 mm)
Electrical component rating:	Pump: 120 V, 7.5 A, 60 Hz
Pump speed:	Single
Minimum flat for door:	2-1/8" (54 mm)

Notes

Measure your actual product for rough-in details. Install this product according to the installation instructions.

The hot water supply should be 70% of the capacity of the bath or greater. Installations will vary.

If installing a rim-mount faucet, make sure there is no interference above or below the deck before drilling any holes.