

**230.1950T | Three Hole Wall Mount Faucet - Trim Only**

**SPECIFICATIONS:**

- Solid Brass construction
- Use with Valve (WLM.1900) - Not Included
- Three Hole Installation
- 1.2 GPM Flow Rate @ 60 PSI
- Extension Available - 230.1950E\*\*

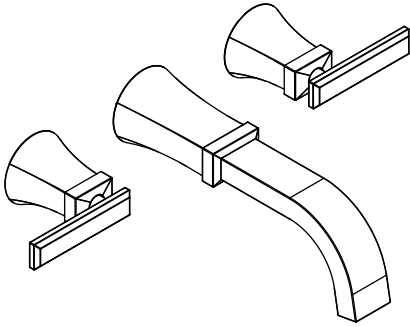

**STANDARDS:**

- ASME A112.18.1 / CSA B125.1, NSF-61

LowFlow Capable



Legislation Compliance



Low Lead Compliant



ZeroDrip Technology



**Technical Diagram**

