



Features

- Available in 27 finishes including 12 PVD finishes
- All brass construction
- Handshower and swivel nut elbow with 1/2" MIP inlets
- Max flow rate: 2.0 gpm (7.6 L/min) or 1.8 gpm (6.8 L/min)
- Durable 84" black poly braided hose, provides quiet non-marring operation
- Includes diverter valve (DDV-R)

60.15.18
60.15.20



Codes/Standards Applicable

Product meets or exceeds the following:

- ASME A112.18.1/CSA B125.1
- NSF 61, NSF 372, CEC (1.8 gpm) & DOE (1.8 & 2.0 gpm)
- EPA WaterSense (2.0 gpm)
- Commonwealth of MA

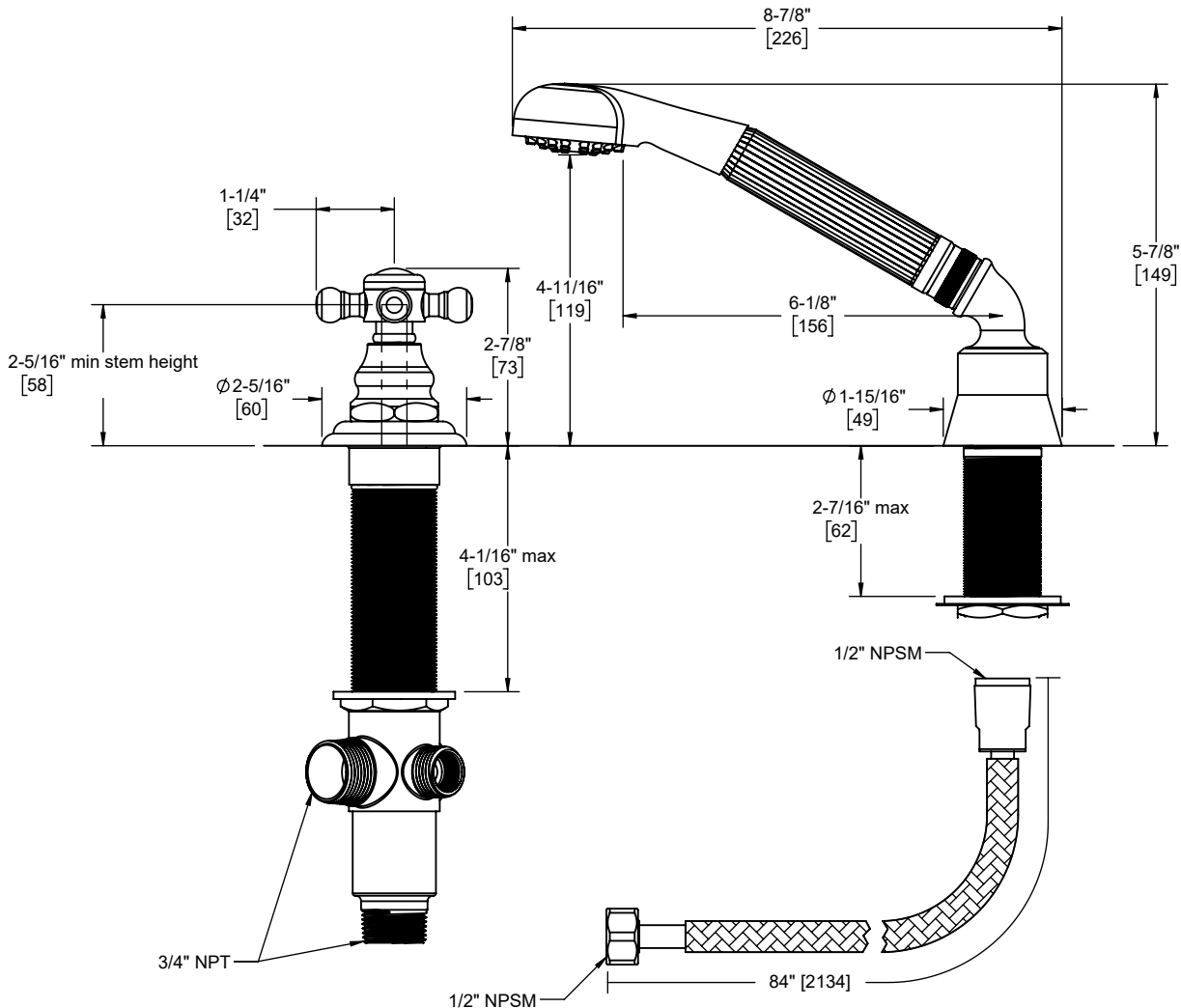

Through-Hole Specifications		
Min	Recommended	Max
Shower: Ø 1-1/4" [32]	Ø 1-1/4" [32]	Ø 1-13/16" [46]
Valve: Ø 1-7/16" [37]	Ø 1-1/2" [38]	Ø 1-3/4" [44]

Dimensions are inches, rounded to 1/16"
[Dimensions in brackets are mm, rounded to 1mm]