

BRIZO®

PRESSURE BALANCE VALVE TRIM

- Litze® Bath Collection
- Valve Trim Only (T60P035-LHP)

FEATURES:

- Touch-Clean® Nozzles

STANDARD SPECIFICATIONS:

- Maintains a balanced pressure of hot and cold water even when a valve is turned on or off elsewhere in the system
- For use with MultiChoice® Universal rough valve body (R60000 Series)
- Max system flow rate 6.3 gpm at 60 psi with R60000-UNBXHF
- Back-to-back installation capability
- Solid brass fabricated body
- Temperature only controlled with handle
- Field adjustable to limit handle rotation into hot water zone
- All parts replaceable from the front of the valve
- Optional extension kit (RP81665) extends rough installation up to 1 3/4"

WARRANTY

- Parts and Finish - Lifetime limited warranty; or for commercial purchasers, 10 years for multi-family residential (apartments and condominiums) and 5 years for all other commercial uses, in each case from the date of purchase.
- Electronic Parts and Batteries (if applicable) - 5 years from the date of purchase; or for commercial purchasers, 1 year from the date of purchase. No warranty is provided on batteries.

COMPLIES WITH:

- ASME A112.18.1 / CSA B125.1
- ASSE 1016

♿ Indicates compliance to ICC/ANSI A117.1 - Valve control only

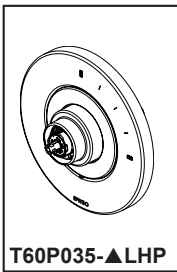

T60P035-▲LHP

Submitted Model No.: _____

Specific Features: _____

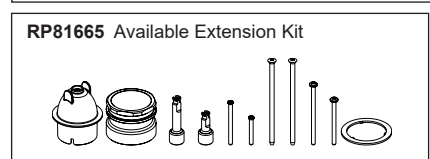
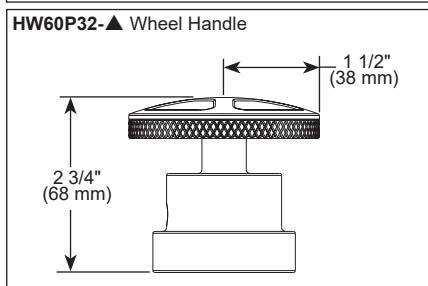
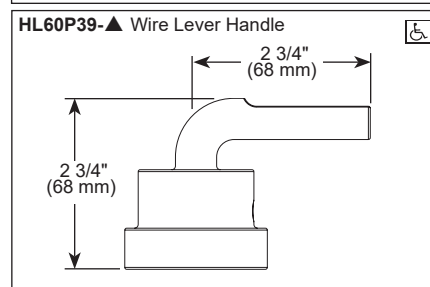
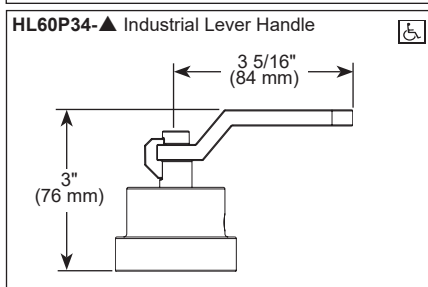
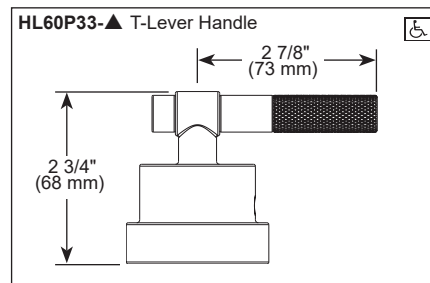
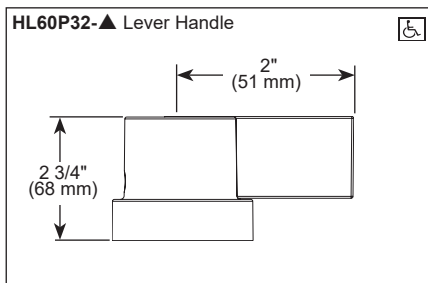
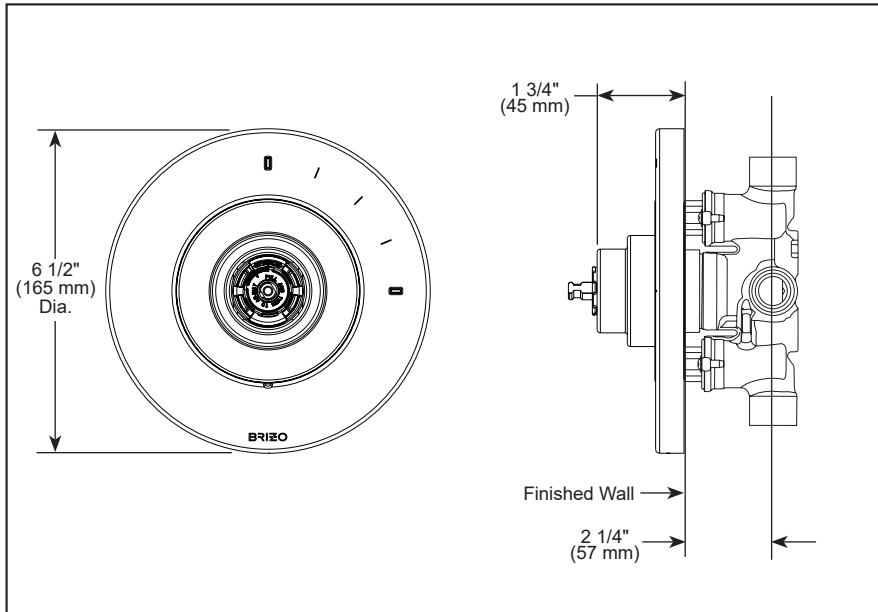

▲ Designate proper finish suffix

Brizo Kitchen & Bath Company reserves the right (1) to make changes in specifications and materials, and (2) to change or discontinue models, both without notice or obligation. Dimensions are for reference only. See current full-line price book or www.brizo.com for finish options and product availability.

BSP-B-T60P035-LHP Rev. A

Brizo Kitchen & Bath Company

55 E. 111th Street, Indianapolis, Indiana 46280
350 South Edgeware Road, St. Thomas, ON N5P 4L1
© 2020 Brizo Kitchen & Bath Company